

ASSEMBLY INSTRUCTIONS

FOR

1988 - 2004 HONDA CIVIC / INTEGRA WITH 2.39 HUB OFFSET*

*For additional vehicle compatibility, visit www.wilwood.com

COMBINATION PARKING BRAKE (CPB) CALIPER REAR BRAKE KIT WITH 11.00" DIAMETER VENTED ROTOR

BASE PART NUMBER

140-10206

**DISC BRAKES SHOULD ONLY BE INSTALLED BY SOMEONE
EXPERIENCED AND COMPETENT IN THE INSTALLATION AND
MAINTENANCE OF DISC BRAKES
READ ALL WARNINGS**

WARNING

IT IS THE RESPONSIBILITY OF THE PERSON INSTALLING ANY BRAKE COMPONENT OR KIT TO DETERMINE THE SUITABILITY OF THE COMPONENT OR KIT FOR THAT PARTICULAR APPLICATION. IF YOU ARE NOT SURE HOW TO SAFELY USE THIS BRAKE COMPONENT OR KIT, YOU SHOULD NOT INSTALL OR USE IT. DO NOT ASSUME ANYTHING. IMPROPERLY INSTALLED OR MAINTAINED BRAKES ARE DANGEROUS. IF YOU ARE NOT SURE, GET HELP OR RETURN THE PRODUCT. YOU MAY OBTAIN ADDITIONAL INFORMATION AND TECHNICAL SUPPORT BY CALLING WILWOOD AT (805) 388-1188, OR VISIT OUR WEB SITE AT WWW.WILWOOD.COM. USE OF WILWOOD TECHNICAL SUPPORT DOES NOT GUARANTEE PROPER INSTALLATION. **YOU**, OR THE PERSON WHO DOES THE INSTALLATION MUST KNOW HOW TO PROPERLY USE THIS PRODUCT. IT IS NOT POSSIBLE OVER THE PHONE TO UNDERSTAND OR FORESEE ALL THE ISSUES THAT MIGHT ARISE IN YOUR INSTALLATION.

RACING EQUIPMENT AND BRAKES MUST BE MAINTAINED AND SHOULD BE CHECKED REGULARLY FOR FATIGUE, DAMAGE, AND WEAR.



Need Additional Information? Use Your
SmartPhone and Jump to Our Technical
Tips Section on Our Web Site.

DISC BRAKES
wilwood

WARNING

**DO NOT OPERATE ANY VEHICLE ON UNTESTED BRAKES!
SEE MINIMUM TEST PROCEDURE WITHIN**

ALWAYS UTILIZE SAFETY RESTRAINT SYSTEMS AND ALL OTHER AVAILABLE SAFETY EQUIPMENT WHILE OPERATING THE VEHICLE

IMPORTANT • READ THE DISCLAIMER OF WARRANTY INCLUDED IN THE KIT

NOTE: Some cleaners may stain or remove the finish on brake system components. Test the cleaner on a hidden portion of the component before general use.

Important Notice - Read This First

Before any tear-down or disassembly begins, review the following information:

- Review the wheel clearance diagram (Figure 2, page 3) to verify that there is adequate clearance with the wheels you will be using with the installation.
- This brake kit is not supplied with hydraulic lines or fittings and may require the purchase of additional lines or fittings to complete the installation. Wilwood offers an extensive listing of brake lines and fittings on our web site: www.wilwood.com.
- This brake kit is not supplied with parking brake cables hardware or adapters. Please see the note in the assembly instructions for additional part numbers of items to purchase.
- Due to OEM production differences and other variations from vehicle to vehicle, the fastener hardware and other components in this kit may not be suitable for a specific application or vehicle.
- It is the responsibility of the purchaser and installer of this kit to verify suitability / fitment of all components and ensure all fasteners and hardware achieve complete and proper engagement. Improper or inadequate engagement can lead to component failure.

Photographic Tip

Important and highly recommended: Take photos of brake system before disassembly and during the disassembly process. In the event, trouble-shooting photos can be life savers. Many vehicles have undocumented variations, photos will make it much simpler for Wilwood to assist you if you have a problem.

Exploded Assembly Diagram

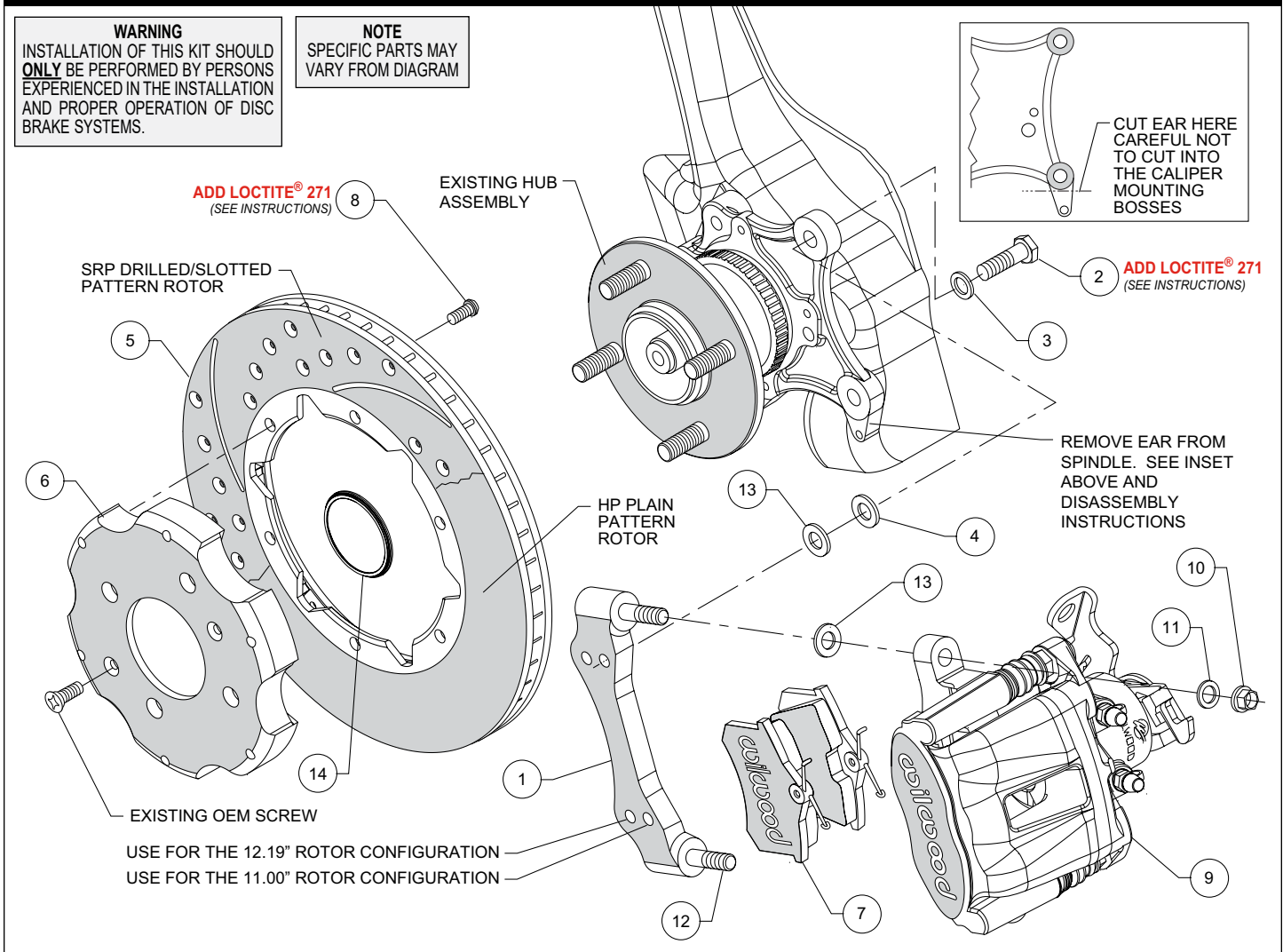

Figure 1. Typical Installation Configuration

Parts List

ITEM NO.	PART NO.	DESCRIPTION	QTY
1	250-10221	Bracket, Caliper Mounting	2
2	230-10195	Bolt, 3/8-16 x 1.25" Long, Hex Head	4
3	240-10190	Washer, .391" I.D. x .625" O.D. x .063" Thick	4
4	240-10306	Shim, .016" Thick	4
5	160-5840	Rotor, HP .81" X 11.00" Dia, 6 x 6.25" Bolt Circle	2
5A	160-7099/7100-BK	Rotor, SRP Drilled and Slotted (one each, right and left)	2
6	170-11682	Hat, 4 x 3.93", .750" Offset, 6 x 6.25" Bolt Circle	2
7	150-9184K	Pad, BP-10, Axle Set	1
8	230-11935	Bolt, 5/16 x 18 x 1.00" Long, Torx Button Head	12
9	120-9808/09-BK	Caliper, CPB, 34 mm (one each, right and left)	2
10	230-16550	Nut, 3/8-24, Self-Locking, 6 Point	4
11	240-10190	Washer, .391" I.D. x .625" O.D. x .063" Thick	4
12	230-9078	Stud, 3/8-16 x 3/8-24 x 2.50" long (pre installed in bracket)	4
13	240-1159	Shim, .035" Thick	20
14	300-14232	Ring, Adapter Registration	2

NOTES: Part Number 230-12176 Rotor Bolt Kit, includes P/N 230-11935

Part Number 230-10216 Bracket Bolt Kit, includes P/N's 230-10195, 240-10190, 240-10306 and 240-1159

Part Number 250-10212 Caliper Bracket Kit, includes P/N's 250-10221, 230-9078, 230-16550, 240-1159 and 240-10190

Item 5A is an optional item and is included with the "-D" kits. Add "-D" to end of part number when ordering

General Information and Disassembly Instructions

- Installation of this kit should **ONLY** be performed by individuals experienced in the installation and proper operation of disc brake systems. Prior to any attempt to install this kit, please check the following to ensure a trouble free installation.
- Inspect the contents of this kit against the parts list to ensure that all components and hardware are included.
- Make sure this is the correct kit to fit the exact make and model year of your axle. This kit is designed for direct bolt-on installation to 1988 through 2004 model year Honda Civic and Integra series hubs.
- Verify your wheel clearance using Figure 2.
- Verify that the factory axle and stud pattern matches the stud hole pattern in the rotors supplied with this kit. Axles that have been modified with different size studs or lug patterns may require modifications to the rotor that must be performed by a qualified machinist.

Disassembly

- Disassemble the original equipment rear brakes: Raise the rear wheels off the ground and support the rear suspension according to the vehicle manufacturer's instructions.
- Remove the rear wheels. Remove the caliper dust shield from the inboard side of the upright and discard, Photo 1. Remove the OEM calipers, and rotors.
- Remove any nicks or burrs on the axle hub and upright that may interfere with the installation of the new brake components.
- Clean, de-grease the axle hub and upright assembly.

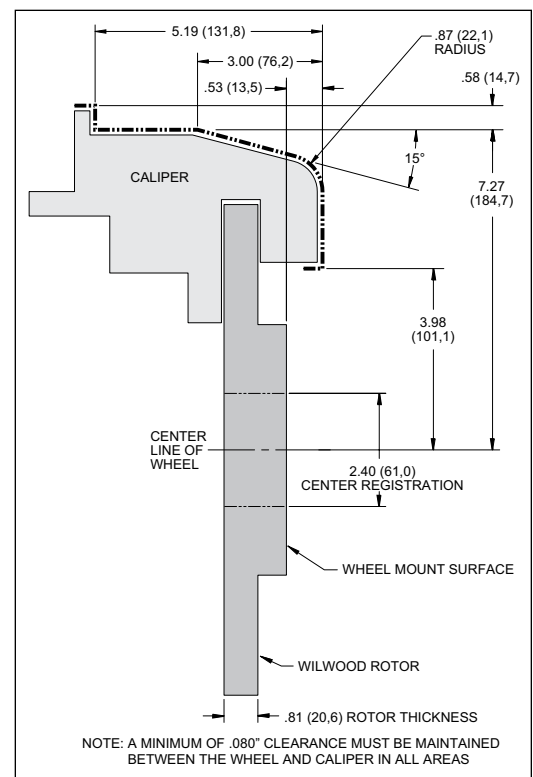

Figure 2. Wheel Clearance Diagram



Photo 1

Upright / Knuckle Modification

• **NOTE:** This modification should be performed and completed before assembly of the Wilwood disc brake kit begins. To properly install the Wilwood caliper bracket, the small mounting ear located by the lower caliper mounting boss must be removed by cutting or grinding as shown in Figure 1 and Photo 2. Remove only enough material to allow flush mounting of the Wilwood bracket to the upright.

• The hub must be removed to access the mounting ear and the four bolts holding the dust shield to the upright face, see Photo 3. Remove the dust shield and discard.

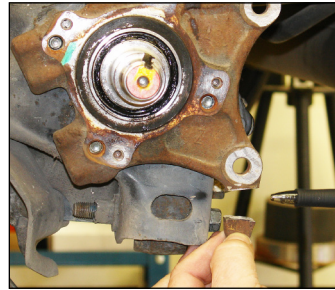

Photo 2



Photo 3

Assembly Instructions (numbers in parenthesis refer to the part list/diagram on the preceding page):

• The caliper mounting bracket (1) should initially be installed with clean, dry threads on the mounting bolts. Orient the bracket as shown in Figure 1 and Photo 5, and install using bolts (2) and washers (3). Initially place one .016" thick shim (4) and one .035" thick shim (13) between the bracket and upright, Figure 1 and Photo 4. Temporarily tighten the mounting bolts. **NOTE:** The bracket must fit squarely against the mount bosses on the upright. Inspect for interference from casting irregularities, machining ridges, burrs, etc. Later, after the caliper alignment has been checked, the mount bolts will be secured using red *Loctite*® 271.



Photo 4

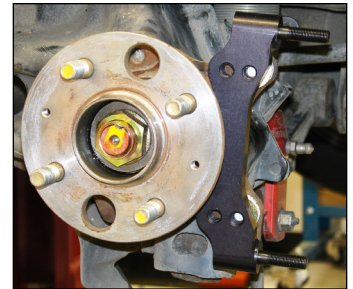

Photo 5

• Orient the rotor (5) and hat (6) as shown in Figure 1 and Photo 6. Attach the rotor to the hat using bolts (8). Using an alternating sequence, apply red *Loctite*® 271 to the threads, and torque to 25 ft-lbs.



Photo 6



Photo 7
Generic Image Shown

• Slide the rotor registration adapter (14) onto the axle register on the axle hub with the smaller O.D. facing outward, Photo 7.

• Slide the hat/rotor assembly onto the axle hub. **NOTE:** The hat must fit flush against the axle hub flange or excessive rotor run out may result. Install OEM screws to keep the hat/rotor assembly in place. Torque screws to OEM specifications.

• Install the brake pads (7) into the caliper (9) from the bottom, with the friction material facing the rotor, until the "v" spring clip snaps into place against the anvil, as shown in Figure 1 and Photo 8. They should install easily without interference.

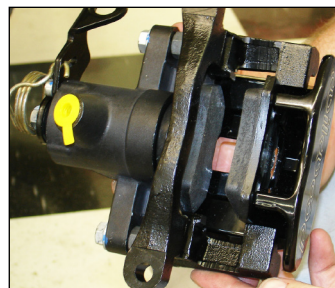

Photo 8



Photo 9

• Initially place two .035" thick shims (13) on each stud as shown in Figure 1. Mount the caliper (9) onto the bracket (1) using lock nuts (10) and washers (11), Figure 1 and Photo 9. Temporarily tighten the lock nuts and view the rotor from the end of the caliper. The rotor should be centered in the caliper, Photo 10. If not, adjust by adding or subtracting shims (4 and/or 13) between the bracket and the upright. Always use the same amount of shims on each of the two mounting bolts. Once the caliper alignment is correct, remove the bracket mounting bolts (2) one at a time, apply red *Loctite*® 271 to the threads, and torque to 35 ft-lb.

Assembly Instructions (Continued)

- Check that the top of the brake pad (7) is flush with the outside diameter of the rotor (5), Photo 11. If not, adjust by adding or subtracting shims (13) between the caliper and the bracket. After the caliper pad height is set, torque the caliper lock nuts (10) to 30 ft-lb.



Photo 10

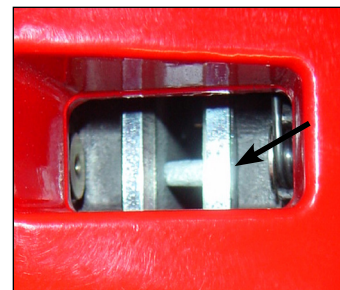

Photo 11

- Temporarily install the wheel and torque the lug nuts to the manufacturer's specification. Ensure that the wheel rotates freely without any interference. Remove wheel for next step.

• **NOTE:** OEM rubber brake hoses generally cannot be adapted to Wilwood calipers. The caliper inlet fitting is M10 x 1.0 banjo. The preferred method is to use banjo fittings at the caliper with enough steel braided line to allow for full suspension travel. **Carefully route lines to prevent contact with moving suspension, brake or wheel components.** Wilwood hose kits are designed for use in many different vehicle applications and it is the installer's responsibility to properly route and ensure adequate clearance and retention for brake hose components. Wilwood offers a hose kit, P/N 220-10840, which includes hoses, fittings, etc., all in one package for this application.

- Specified brake hose kits may not work with all Years, Makes and Models of vehicle that this brake kit is applicable to, due to possible OEM manufacturing changes during a production vehicle's life. It is the installer's responsibility to ensure that all fittings and hoses are the correct size and length, to ensure proper sealing and that they will not be subject to crimping, strain and abrasion from vibration or interference with suspension components, brake rotor or wheel.

- In absence of specific instructions for brake line routing, the installer must use his best professional judgment on correct routing and retention of lines to ensure safe operation. Test vehicle brake system per the '**Minimum Test Procedure**' stated within this document before driving. After road testing, inspect for leaks and interference. Initially after install and testing, perform frequent checks of the vehicle brake system and lines before driving, to confirm that there is no undue wear or interference not apparent from the initial test. Afterwards, perform periodic inspections for function, leaks and wear in a interval relative to the usage of vehicle.

- Bleed the brake system. Reference the '**Additional Information and Recommendations**' on page 6 for proper bleeding instructions.

IMPORTANT:

- To ensure maximum performance from your parking brake system, the cables must be routed as straight as possible. Bends in the cable can significantly reduce efficiency and thus reduce pull force at the brake. Tight bends must be avoided with a minimum recommended bend radius of 6" to 8".
- Cables should be properly restrained to prevent "straightening" of bends when tension is applied. Restrain movement of cable by affixing the cable sheath to body or chassis by fitting cable clamps at various points over the length of cable or by using original equipment cable attachments points. The clamping method chosen will require that cable sheath be held tightly without movement, crushing or causing interference to the internal cable.
- Cables must be initially pre-stretched by multiple applications of the brake handle, then re-adjusted to correct tension.

- Install new parking brake cable (not included in kit). **NOTE:** Original equipment cable will not adapt to Wilwood calipers. Wilwood offers a custom parking brake cable kit, P/N 330-10966 for this application which can be ordered separately from your local Wilwood dealer or by calling Wilwood customer service at (805) 388-1188.

- Follow the instructions supplied with the parking brake cable kit, DS-685 (also available at www.wilwood.com/PDF/DataSheets/ds685.pdf).

- Install the wheel and torque lug nuts to manufacturer's specification.

Assembly Instructions (Continued)

ADJUST PARKING BRAKE:

1. With the parking brake lever released, adjust both cables at balance bar to remove any excess cable slack, without actuating the caliper levers.
 2. Depress and hold brake pedal using moderate leg pressure. While maintaining leg pressure on the pedal, completely engage and disengage parking brake lever until lever tension becomes consistent. This will set the adjusting mechanism for the parking brake while tightening the lever feel.
- Bed-in the brake pads per the procedure on page 7.
 - After brake pads have been bedded, carefully test the holding power of the parking brakes. Test parking brake in a safe area, first on a flat surface by pushing on the vehicle, then on a slight incline by applying and releasing handle multiple times.

Additional Information and Recommendations

• **NOTE:** *With the installation of after market disc brakes, the wheel track may change depending on the application. Check your wheel offset before final assembly.*

- Please read the following concerning balancing the brake bias on 4 wheel disc vehicles.

This Honda rear brake kit can be operated using the stock OEM master cylinder. However, as with most suspension and tire modifications (from OEM specifications), changing the brakes may alter the front to rear brake bias. Rear brakes should not lock up before the front. Brake system evaluation and tests should be performed by persons experienced in the installation and proper operation of brake systems. Evaluation and tests should be performed under controlled conditions. Start by making several stops from low speeds then gradually work up to higher speeds. Always utilize safety restraint systems while operating vehicle.

- For optimum performance, fill and bleed the new system with Wilwood Hi-Temp[®] 570 grade fluid or EXP 600 Plus. For severe braking or sustained high heat operation, use Wilwood EXP 600 Plus Racing Brake Fluid. Used fluid must be completely flushed from the system to prevent contamination. **NOTE:** *Silicone DOT 5 brake fluid is **NOT** recommended for racing or performance driving.*

- To properly bleed the brake system, begin with the caliper farthest from the master cylinder. Bleed the outboard bleed screw first, then the inboard. Repeat the procedure until all calipers in the system are bled, ending with the caliper closest to the master cylinder. If the caliper is fitted with bleed screws on four corners, make sure the bottom bleed screws are tight. Only bleed from the top bleed screws. **NOTE:** *When using a new master cylinder, it is important to bench bleed the master cylinder first.*

- Test the brake pedal. It should be firm, not spongy, and stop at least 1 inch from the floor under heavy load.
If the brake pedal is spongy, bleed the system again.

If the brake pedal is initially firm, but then sinks to the floor, check the system for leaks. Correct the leaks (if applicable) and then bleed the system again.

If the brake pedal goes to the floor and continued bleeding of the system does not correct the problem, either air may be trapped in the system, or a master cylinder with increased capacity (larger bore diameter) may be required. Wilwood offers various lightweight master cylinders with large fluid displacement capacities (custom fabricated mounting may be required).

Brake Testing

WARNING • DO NOT DRIVE ON UNTESTED BRAKES BRAKES MUST BE TESTED AFTER INSTALLATION OR MAINTENANCE MINIMUM TEST PROCEDURE

- Make sure pedal is firm: Hold firm pressure on pedal for several minutes, it should remain in position without sinking. If pedal sinks toward floor, check system for fluid leaks. DO NOT drive vehicle if pedal does not stay firm or can be pushed to the floor with normal pressure.
- At very low speed (2-5 mph) apply brakes hard several times while turning steering from full left to full right, repeat several times. Remove the wheels and check that components are not touching, rubbing, or leaking.
- Carefully examine all brake components, brake lines, and fittings for leaks and interference.
- Make sure there is no interference with wheels or suspension components.
- Drive vehicle at low speed (15-20 mph) making moderate and hard stops. Brakes should feel normal and positive. Again check for leaks and interference.
- Always test vehicle in a safe place where there is no danger to (or from) other people or vehicles.
- Always wear seat belts and make use of all safety equipment.

Pad and Rotor Bedding

BEDDING STEPS FOR NEW PADS AND ROTORS – ALL COMPOUNDS

Once the brake system has been tested and determined safe to operate the vehicle, follow these steps for the bedding of all new pad materials and rotors. These procedures should only be performed on a race track, or other safe location where you can safely and legally obtain speeds up to 65 MPH, while also being able to rapidly decelerate.

- Begin with a series of light decelerations to gradually build some heat in the brakes. Use an on-and-off the pedal technique by applying the brakes for 3-5 seconds, and then allow them to fully release for a period roughly twice as long as the deceleration cycle. If you use a 5 count during the deceleration interval, use a 10 count during the release to allow the heat to sink into the pads and rotors.
- After several cycles of light stops to begin warming the brakes, proceed with a series of medium to firm deceleration stops to continue raising the temperature level in the brakes.
- Finish the bedding cycle with a series of 8-10 hard decelerations from 55-65 MPH down to 25 MPH while allowing a proportionate release and heat-sinking interval between each stop. The pads should now be providing positive and consistent response.
- If any amount of brake fade is observed during the bed-in cycle, immediately begin the cool down cycle.
- Drive at a moderate cruising speed, with the least amount of brake contact possible, until most of the heat has dissipated from the brakes. Avoid sitting stopped with the brake pedal depressed to hold the car in place during this time. Park the vehicle and allow the brakes to cool to ambient air temperature.

COMPETITION VEHICLES

- If your race car is equipped with brake cooling ducts, blocking them will allow the pads and rotors to warm up quicker and speed up the bedding process.
- Temperature indicating paint on the rotor and pad edges can provide valuable data regarding observed temperatures during the bedding process and subsequent on-track sessions. This information can be highly beneficial when evaluating pad compounds and cooling efficiencies.

Pad and Rotor Bedding (Continued)

POST-BEDDING INSPECTION – ALL VEHICLES

- After the bedding cycle, the rotors should exhibit a uniformly burnished finish across the entire contact face. Any surface irregularities that appear as smearing or splotching on the rotor faces can be an indication that the brakes were brought up to temperature too quickly during the bedding cycle. If the smear doesn't blend away after the next run-in cycle, or if chatter under braking results, sanding or resurfacing the rotors will be required to restore a uniform surface for pad contact.

PRE-RACE WARM UP

- Always make every effort to get heat into the brakes prior to each event. Use an on-and-off the pedal practice to warm the brakes during the trip to the staging zone, during parade laps before the flag drops, and every other opportunity in an effort to build heat in the pads and rotors. This will help to ensure best consistency, performance, and durability from your brakes.

DYNO BEDDED COMPETITION PADS AND ROTORS

- Getting track time for a proper pad and rotor bedding session can be difficult. Wilwood offers factory dyno-bedded pads and rotors on many of our popular competition pads and **Spec 37** GT series rotors. Dyno-bedded parts are ready to race on their first warm up cycle. This can save valuable time and effort when on-track time is either too valuable or not available at all, Dyno-bedding assures that your pads and rotors have been properly run-in and are ready to go. Contact your dealer or the factory for more information on Wilwood Dyno-Bedding services.

NOTE: NEVER allow the contact surfaces of the pads or rotors to be contaminated with brake fluid. Always use a catch bottle with a hose to prevent fluid spill during all brake bleeding procedures.

Parking Brake

WARNING • PARKING BRAKE

- Parking brake must be properly adjusted before use and must be manually readjusted for wear if parking brake handle or foot lever travel becomes excessive.
- The holding ability of the brake should be tested by stopping on a sloping surface and applying the parking brake while holding car with the hydraulic foot brake. This should be accomplished both facing up and down hill.
- Do not rely exclusively on the parking brake to hold the car; Curb wheels as recommended by the applicable diagram and put gear selector in park, or shift into first gear or reverse with a manual transmission.

- Diagram A - When parking facing downhill, turn front wheels towards the curb or right shoulder. This will keep from rolling into traffic if the brakes become disengaged.
- Diagram B - Turn the steering wheel to the left so the wheels are turned towards the road if you are facing uphill with a curb. The tires will catch the curb if the car rolls backward.
- Diagram C - When facing uphill without a curb, turn the wheels sharply to the right. If the vehicle rolls, it will go off the road rather than into traffic.
- When parking on a hill, always set the parking brake and move the gear selector into park, or shift into first or reverse gear if your vehicle has a manual transmission.

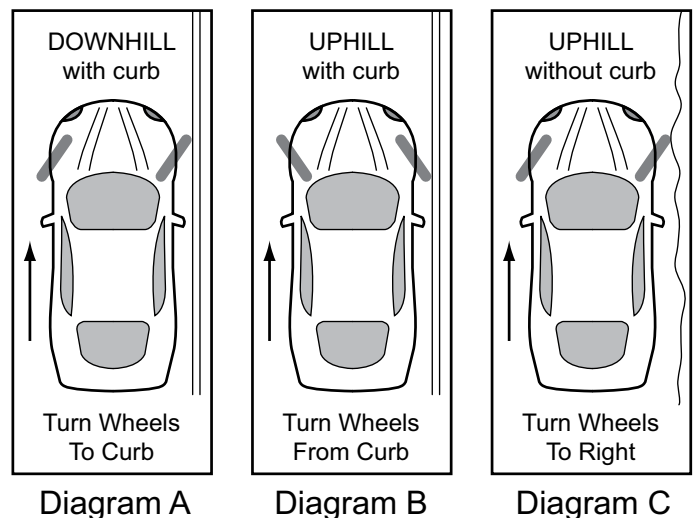

Connect with Wilwood

Wilwood Facebook 

Wilwood Instagram 

Wilwood Twitter 

Wilwood YouTube 

Associated Components

<u>PART NO.</u>	<u>DESCRIPTION</u>
260-13706	Wilwood Residual Pressure Valve (2 lb for disc brakes)
260-13707	Wilwood Residual Pressure Valve (10 lb for drum brakes)
260-8419	Wilwood Proportioning Valve, Knob Style
260-8420	Wilwood Proportioning Valve, Lever Style
260-11179	Wilwood Combination Proportioning Valve with Brake Light Switch
290-0632	Wilwood Racing Brake Fluid (Hi-Temp ^o 570) (12 oz)
290-6209	Wilwood Racing Brake Fluid (EXP 600 Plus) (16.9 oz)
340-13831	Wilwood Floor Mount Brake Pedal (with balance bar)
340-13832	Wilwood Swing Mount Brake Pedal (with balance bar)
260-6764	Wilwood 3/4 inch High Volume Aluminum Master Cylinder
260-6765	Wilwood 7/8 inch High Volume Aluminum Master Cylinder
260-6766	Wilwood 1 inch High Volume Aluminum Master Cylinder
260-4893	1-1/16 inch Tandem Master Cylinder (aluminum housing)
260-8555	Wilwood 1 inch Aluminum Tandem Chamber Master Cylinder
260-8556	Wilwood 1-1/8 inch Aluminum Tandem Chamber Master Cylinder
220-10840	Stainless Steel Braided Flexline Kit, Honda Civic/Integra with CPB Caliper
330-10966	Parking Brake Cable Kit, Honda Civic/Integra with CPB Caliper